

Majority Rule Based True Democracy Under Complacency Theory: Pointing Out The Structure of Normal and of Extreme Democratic Outcomes Analytically and Graphically.

By

Lucio Muñoz*

* Independent Qualitative Comparative Researcher / Consultant, Vancouver, BC, Canada Email: munoz@interchange.ubc.ca

Abstract

The coming of extreme democratic outcomes took the whole democratic world by surprise in June 2016 with the BREXIT win in the UK endorsing the move to leave the European Union; and the USEXIT results in the USA in November 2016 electing Donald Trump as President, both events leading to after the fact wide spread true majority discontent and protest. Yet still today September 2017, not much is known about what is the structure of extreme democratic outcomes and about when they should be expected to take place. We know now for sure that normal democratic modeling and polling cannot foresee the coming of extreme democratic outcomes; and therefore they are not helpful to understanding how to avoid them or how to deal with them once they happen. Hence, new ideas are needed to understand the world and the working of extreme democratic outcomes.

Among the goals of this paper is to provide answers, both analytically and graphically, to the following two questions: a) under which complacency conditions we should always expect the true majority to win a democratic contest and see normal democratic outcomes(NDO)?; and b) under which complacency conditions we should expect the true minority to win a democratic contest leading to surprising extreme democratic outcomes(EDO)?.

Key concepts complacency, extreme

Majority rule, democracy, true democracy, complacency, partial complacency, full complacency, democratic outcomes, normal democratic outcomes, extreme democratic outcomes, true majority complacency, true minority complacency, full participation assumption, full voting assumption, complacency assumption.

Introduction

a) True democracy

Other things being equal, true democracy can be defined as the system that provides equal opportunity to participate in the determination of democratic outcomes through voting systems to different individuals and groups within a society. In other words, true democracy is a system of the people, by and for the people(Becker and Reveloson 2008) where each individual has an equal right to participate, to be represented and to share in the benefits(UN 1976), which provides the ideal conditions for the respect of all rights(DW 2017) of individuals and groups.

If we assume that there are two groups of individuals in a democratic society, G_1 and G_2 , then true democracy(TD) bring those two groups together to compete in a voting system(V_1) and determine that way the democratic outcome(DO), a situation that is reflected in Figure 1 below:

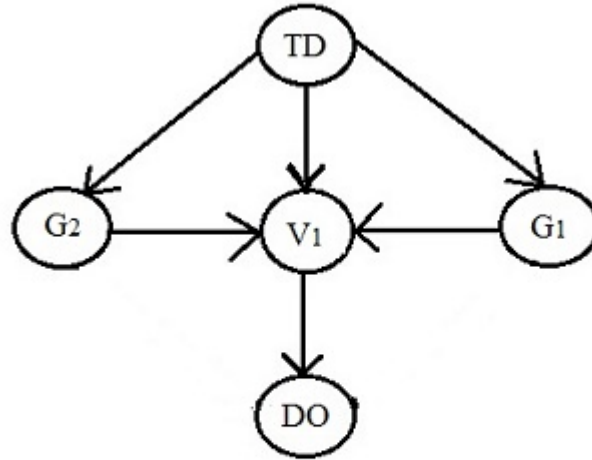

Figure 1 The true democracy model: The link between true democracy(TD) and the democratic outcome(DO) is equal participation in the voting system(V_1)

Figure 1 above simply says that in a true democracy(TD) brings together different groups of individuals G_1 and G_2 through a voting system(V_1) to determine the democratic outcome(DO) that will rule that democracy(D).

Notice that that democratic outcome(DO) could be a normal democratic outcome(NDO) or an extreme democratic outcome(EDO) depending on whether the winning group, G_1 or G_2 , reflects the interest of the majority or the interest of the minority. In other words, in a true democracy(TD) model without clear voting rules governing the determination of democratic outcomes(DO) as the one shown in Figure 1 above any democratic outcome(DO) is possible, even extreme democratic outcomes(EDO).

b) Majority rule based voting system

Other things being equal it can be said that a majority rule based voting system(V), one person, one vote, ensures the creation of normal democratic outcomes(NDO) by requiring every voter to vote for the candidate of their choice creating that way true majorities and true minorities, where the will of the majority rules. In other words, in the majority rule based system, ceteris paribus, the group that gathers the highest number of votes or the true majority(T) wins the election or the day; and the group that gets the minority vote or the true minority(M) loses. It has been said that at the center of making democratic decisions is majority rule(DW 2017) even so some believe that it provides legitimacy to acts of tyranny(Williams 2009).

If we assume that there are two blocks of individuals in a democratic society, a true majority T and true minority M, then those two groups get together to compete in a voting system(V) and determine that way the democratic outcome(DO) producing a normal democratic outcome(NDO) as $T > M$; and therefore the true majority T wins, which is the

situation reflected in Figure 2 below

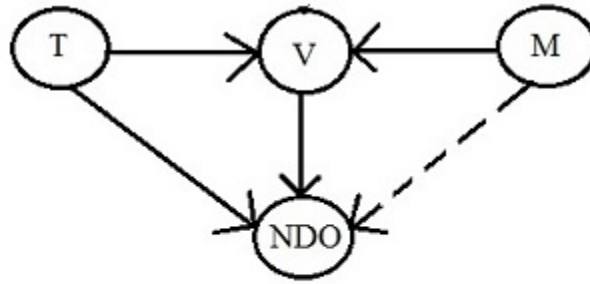

Figure 2 Majority rule based voting system(V): It brings together the true majority(T) and the true minority(M), where the true majority wins($T > M$) ensuring a normal democratic outcome(NDO).

As it can be seen in Figure 2 above, the majority rule based voting system(V) supported on a one voter one vote and everybody must vote assumption ensures only normal democratic outcomes(NDO) where the will of the true majority T prevails. Notice in Figure 2 above that the continuous line arrow from T to NDO means the true majority T wins; and the broken line arrow from M to NDO indicates the true minority M loses.

c) Linking true democracy to the majority rule based voting system

Other things being equal, it can be said that democratic societies which provide equal right to participate to each individual prefer the rule of normal democratic outcomes(NDO) where the will of the majority wins; and therefore, they subject their democratic system to the majority rule based voting system(V). Most of the freest 28 presidential democracies have a majority rule based decision-making system(Lewis et al 2006) reflecting the equal right and responsibility individuals have to participate in public affairs(HRC 2016). Hence, each democratic option like a new government, a national plebiscite, the breakup of a country or the breakup of a union or a new constitution and so on is usually expected to be geared to motivate the true majority or to create a true majority to win the competition. In other words, in the majority rule based system after counting the all votes we need to have a true majority (e.g. be it left or be it right or center; or be it poor or rich or middle class) and a true minority (e.g. be it left or be it right or center; or be it poor or rich or middle class) determining the government or key decision of the day and its initial stability.

If we assume the following: i) that there are two groups of individuals in society competing to determine a democratic outcome, G_1 and G_2 ; ii) that $G_2 > G_1$ and therefore, following is true, $G_2 = T =$ true majority; and $G_1 = M =$ true minority; and therefore $T > M$ as everyone participates and votes as expected, which leads to the matching of the numbers of votes to the number of voters; and iii) that the voting system(V1) of the true democracy(TD) is under majority rule(V) so that $V_1 = V$, then we can link the true democracy model(TD) to the majority rule based voting system(V) as shown in Figure 3 below:

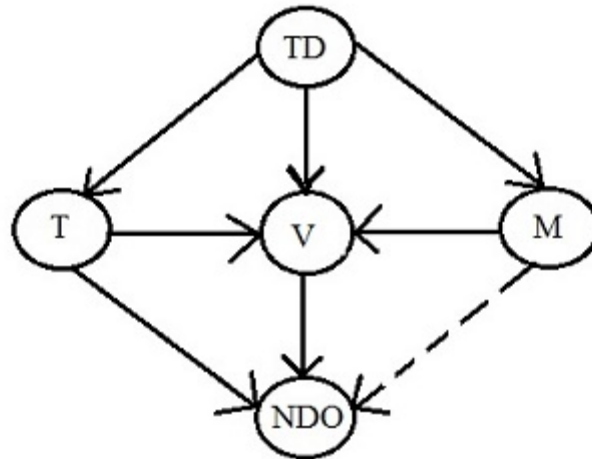

Figure 3 Linking the true democracy model(TD) to the majority rule based voting system(V) by making $V1 = V$, then we ensure only normal democratic outcomes(NDO) where the true majority(T) wins as $T > M$.

Figure 3 above simply says that under the majority rule based system(V) the true democracy model(TD) produces only normal democratic outcomes(NDO) as the true majority(T) wins since $T > M$. Again notice that in Figure 3 above that the continuous line arrow from T to NDO means the true majority T wins; and the broken line arrow from M to NDO indicates the true minority M loses.

d) The assumption of no complacency(NC)

Notice that the structure in Figure 3 above holds true as equal right to participate is provided to all individuals and all individuals are expected to vote, and the majority group T resulting from the voting process is set to win the contest and form the heart of the normal democratic outcome(NDO). When every individual or voter is expected to vote for their preferred candidate or option so that the total number of votes matches the total number of voters in the system, then there is an assumption of no complacency(NC). There is an equal right to participate(HRC 2016); and therefore, an equal expectation of the responsibility to vote. In other words, the structure in Figure 3 above assumes full participation and full voting; and therefore the voting system(V) is not affected by protest behavior like protest participation and protest votes, which is the situation summarized in Figure 4 below:

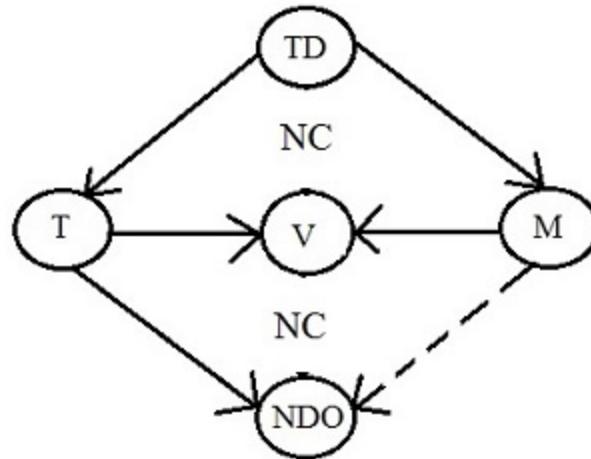

Figure 4 The true democracy model(TD) and the majority based voting system(V) under the no complacency assumption(NC) leads to normal democratic outcomes(NDO).

Figure 4 above states that when there is no complacency(NC) or protest behavior the true democracy(TD) model under a majority rule voting system(V) produces only normal democratic outcomes(NDO) as the true majority T wins since $T > M$. The continuous line arrow from T to NDO indicates as mentioned before that the true majority T wins; and the broken arrow from M to NDO says that true minority M loses.

In other words, Figure 4 above tells us that under no complacency(NC) we should expect the democratic outcome(DO) to be a normal democratic outcome(NDO) as there is full equal participation and everyone in the true majority(T) and in the true minority(M) votes for their true majority and true minority candidates respectively.

Notice that the situation in Figure 4 above holds true because of the assumption of protest behavior neutrality, there is no protest behavior affecting the true democracy model nor the majority rule model as full participation and full voting is expected to take place: When protest behavior is assumed away there is no complacency(NC); and therefore, there is full participation and full voting at the same time under no complacency(NC).

e) The need to link complacency theory to extreme democratic outcomes

If people are not happy with the way the democratic system is working or they can no longer feel the system is working well for them, then voting behavior can take a negative trend in terms of democratic participation. This negative behavior affects both the participation of the true majority and the participation of the true minority as it can lead to a smaller proportion of eligible voters from all camps to actually vote and/or it can lead to a proportion of eligible voters from both camps to use an array of protest vote. For example internal party division such as those in the 2016 Democratic Party contest, Clinton vrs Sanders(TT 2016); and those in the 2016 Republican Party contest, Trump vrs GOP(BBC 2016a) lead to internal complacency or protest behavior. External party or front divisions such as in the 2016 Clinton vrs Trump contest(TGAM 2016a: CT 2016); and those in the

2016 stay vrs leave contest in the UK referendum(Gore 2016; BBC 2016b) create external complacency or protest behavior.

And therefore, all these possible negative democratic actions indicated above reflect complacency behavior(C), general or partial, internally or externally driven, that can affect directly the actual outcome of the voting system as it can affect how the true majority or the true minority or both actually votes on election or voting day. Hence, complacency behavior(C) is in essence protest behavior. In other words, under complacency(C) behavior a normal democratic outcome(NDO) is no longer a sure thing as protest behavior can lead to even outcomes thought to be impossible to happen happen as it is the case extreme democratic outcomes(EDO) such as the case in June 2016 in the UK(Cohn 2016a; BBC 2016c) where UK's BREXIT won; and the case of November 2016 in the USA(Byers 2016; Ingram 2016) where Trump's USEXIT won.

Now let's assume for a while that there is complacency(C) or protest behavior, be it partial complacency(PC) or full complacency(FC) in the voting system as not everybody in the true majority camp(T) and in the true minority camp(M) participates or votes as expected, bringing unpredictability in the determination of the democratic outcome(DO), a situation reflected in Figure 5 below:

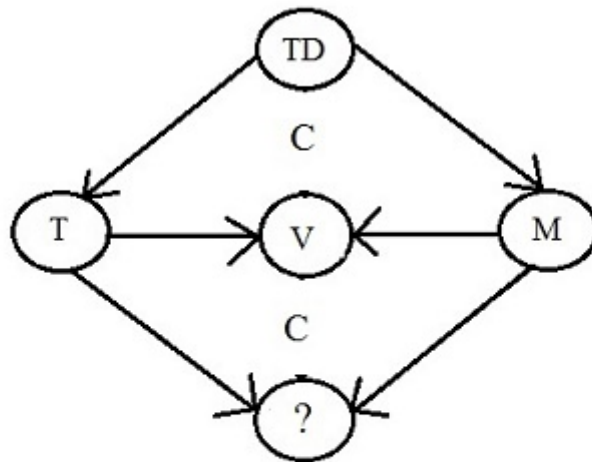

Figure 5 When the true democracy model(TD) and the majority rule based voting system(V) are under complacency(C) you do not know who will win, it could be a normal democratic outcome(NDO) or it could be an extreme democratic outcome(EDO) depending of the type of complacencies at play.

Figure 5 above shows that when there is complacency(C) the outcome of the democratic contest(DO) is unknown(?) as we do not know if the true majority(T) or the true minority(M) will win, all depends on the type of complacency affecting the behavior of the true majority(T) and the true minority(M) in that democratic system at that time.

The continuous arrows from T and M to ? tells us that we do not know who will win the democratic contest under complacency(C) as the system is under protest behavior.

The above means that a normal democratic outcome(NDO) is no longer a guaranteed thing under complacency(C) as now the possibility of having an extreme democratic outcome(EDO) exists if as the result protest behavior the true minority(M) were to win the democratic contest. In other words, protest behavior or complacency(C) can make what it seems impossible to happen happen such as it is the case of extreme democratic outcomes(EDO) such as UK's 2016 leave win(Jackson 2016) or BREXIT; and Trump's 2016 win(Hohmann 2016) or USEXIT.

f) The urgent need to understand the world and the working of extreme democratic outcomes

The coming of extreme democratic outcomes took the whole democratic world by surprise in June 2016 with the BREXIT win in the UK endorsing the move to leave the European Union(BBC 2016c); and the USEXIT results in the USA in November 2016 electing Donald Trump as President(Rawlinson 2016), both events leading to after the fact wide spread true majority discontent and protest. In the case of BREXIT the surprise has led to questions such as is there a way back?(Wintour 2016), it is the collective good destructed?(Gifford 2016) or did we cover the referendum dynamics properly?(Gaber 2016). In the case of the USEXIT surprise the questions are why Trump won?(Cohn 2016b), why we could not predict it?(Ingram 2016) or what happens now?(TGAM 2016b).

Yet still today September 2017, not much is known about what is the structure of extreme democratic outcomes(EDO), the structure under which outcomes such as BREXIT and USEXIT take place; and therefore, not much is known about when extreme democratic outcomes should be expected to take place. We know now for sure as documented above that normal democratic modeling and polling cannot foresee the coming of extreme democratic outcomes(EDO); and therefore, they are not helpful to understanding how to avoid them or how to deal with them once they happen. It was shown recently that under normal democratic conditions the democratic contest of the liberal model is a choice between moral practicality and practical morality(Muñoz 2015), a process that tends towards a more sustainable state as it is based on facts and science as morality matters under normal democratic outcomes(NDO).

We know now that under abnormal democratic conditions the democratic contest of the liberal model becomes a hard to see choice between a normal democratic outcome(NDO) under majority rule and an extreme democratic outcome(EDO) under minority rule, a process that tends towards a chaotic state as it is a clash between facts and fake facts, between science and non-science as morality matters only to those in favor of majority rule, but it does not matter to those in favor of minority rule. We know that extreme democratic outcomes flourish under conspiracy theories and fake news as both the case of BREXIT(Rentoul 2016; BT 2016; Grice 2017) and of USEXIT(Uscinski 2016; Horton 2016; Rogers and Bromwich 2016) show. Hence, new ideas are needed to understand the world and the working of extreme democratic outcomes(EDO).

Among the goals of this paper is to provide answers, both analytically and graphically, to the following two questions: a) under which complacency conditions we should always expect the true majority to win a democratic contest and see normal democratic outcomes(NDO)?; and b) under which complacency conditions we should

expect the true minority to win a democratic contest leading to surprising extreme democratic outcomes(EDO)?.

Objectives

The goals of this paper are: a) to stress the complacency conditions under which we should always expect the true majority to win a democratic contest leading to normal democratic outcomes(NDO) both analytically and graphically; b) to highlight the complacency conditions under which we should expect the true minority(M) to win a democratic contest leading to surprising extreme democratic outcomes(EDO) both analytically and graphically; and c) to share a summary and implications associated with both the nature of normal democratic outcomes(NDO) and nature of extreme democratic outcomes(EDO).

Methodology

First, the terminology used in this paper is listed. Second, operational concepts and operational models are introduced. Third, the true majority based voting model is pointed out both analytically and graphically. Fourth, the true majority based voting model under no complacency is indicated both analytically and graphically. Fifth, the true majority based voting model under complacency is highlighted both analytically and graphically. Sixth, the true majority based voting model under full true majority complacency is shared both analytically and graphically. Seventh, the true majority based voting model under partial true majority complacency is stressed both analytically and graphically. Eighth, a summary and implications related to the nature of normal democratic outcomes and the nature of extreme democratic outcomes is given. And finally, some food for thoughts and relevant conclusions are provided.

Terminology

V = Voting model

V_i = Voter "i"

G_1 = Group of voters 1

G_2 = Group of voters 2

T = True majority

M = true minority

D = Democracy

TD = True democracy

T = Dominant/active component

t = Dominated/passive component

M = Dominant/active component

m = Dominated/passive component

C = Complacency

NC = No complacency

TC = True majority complacency	TNC = True majority no complacency
MC = True minority complacency	MNC = True minority no complacency
FTC = Full true majority complacency	PTC = Partial true majority complacency
FMC = Full true minority complacency	PMC = Partial true minority complacency
NDO = Normal democratic outcome	EDO = Extreme democratic outcome
BREXIT = UK June 2016 outcome	USEXIT = USA November 2016 outcome
ND = No democracy exists	CRE = Complacency rule expectations

Operational concept and operational models

A) *Operational concepts*

a) Democracy, *system that aims at providing equal opportunity to elect, to be represented, and to share in the benefits to all its members;*

b) True democracy, *there is equal opportunity in all democratic aspects at the same time;*

c) Partially distorted democracy, *there is not equal opportunity in at least one democratic aspect;*

d) Fully distorted democracy, *there is inequality of opportunity in all democratic aspects at the same time;*

e) Majority rule system, *the electoral system where the majority rules decides the winner of democratic contexts;*

f) Voters, *each individual in the electoral system acting without complacency and who is committed to make sure his vote or her vote is counted in the determination of the democratic outcome with the goal to maintain or improve his current or future benefits and rights;*

g) True majority, *the actual number of voters who win the democratic context;*

h) True minority, *the actual number of voters who lose the democratic context;*

i) Complacency, *the social discontent or protest or frustration affecting opposing groups with the given democratic or electoral system choices that may lead voters from the true*

majority and/or the true minority to not vote at all or if they vote they go for a protest vote by either voiding their vote or shifting their vote to other choices in the belief that their party will still win or will still lose anyway without their vote or in the belief that their vote is just one vote anyway and it will not matter in the end result; Hence, complacency based voting is linked to pure dissatisfaction as voting behavior takes place without thinking much about the impact that this action may have in the end on the balance of current and future majority and minority democratic rights;

j) No complacency, *the absence of social discontent or protest or frustration with the democratic or electoral system that leads each voter from each group to vote for their preferred democratic choice to ensure his or her vote is counted, therefore no complacency based voting is linked either to ensuring the preservation and enhancing of current democratic rights in one group or linked to seeking the erosion or change of those rights or to slowing the pace of democratic change in the other group;*

k) Partial complacency, *the partial social discontent or protest or frustration with the democratic or electoral choices is not widespread; some voters do not vote or cast a protest vote;*

l) Full complacency, *the general social discontent or protest or frustration with the democratic or electoral choices is widespread; many voters do not vote or cast a protest vote;*

m) True majority complacency, *it can be partial or full, voters do not show to vote or spoil the vote or shift votes in a show of social discontent or protest or frustration;*

n) True minority complacency, *it can be partial or full, voters do not show to vote or spoil the vote or shift votes in a show of social discontent or protest or frustration;*

o) True majority no complacency, *everybody in the true majority camp votes for their preferred candidate, no protest votes take place;*

p) True minority no complacency, *everybody in the true minority camp votes for their preferred candidate, no protest votes take place;*

q) Normal democratic outcome, *under no complacency or not protest behavior everybody votes and the true majority wins the democratic contest, governments retain or lose power without big surprises. Inclusion, equality, stability, harmony, the truth, trust, clarity, scientific facts, and the will of the majority for the common good are the heart of normal democratic outcomes.*

r) Extreme democratic outcome, *under full true majority complacency or full true majority protest behavior the true minority wins the democratic context, governments lose or win power under a big surprise as the democratic option that seems impossible to happen wins the day. Exclusion, inequality, instability, chaos, fake truth, fake trust,*

confusion, fake facts, and the will of the minority for the good of the minority are the heart of extreme democratic outcomes.

s) Internal complacency, *social discontent or protest or frustration generated by internal group divisions(e.g. divisive choice/leader selection);*

t) External complacency, *social discontent or protest or frustration generated by external group divisions(e.g. equally disliked competing choices/leaders);*

u) Full democracy, *a full inclusion model, a true democracy;*

v) Partial democracy, *a partial inclusion model, a distorted democracy;*

x) Democratic stability, *the tendency towards harmony associated with specific democratic outcomes;*

y) Full democratic stability, *the tendency towards full harmony associated with normal democratic outcomes;*

z) Full democratic instability, *the tendency towards zero harmony associated with extreme democratic outcomes.*

B) Operational models

a) The democratic outcome line(L)

The democratic outcome resulting from following the majority rule based system can be represented in Figure 6 below assuming a) there are two groups of voters, G_1 and G_2 where group $G_2 > G_1$ and therefore $G_2 = T > G_1 = M$; and b) that G_1 got X number of votes and G_2 obtained Y number of votes; and hence, $Y > X$:

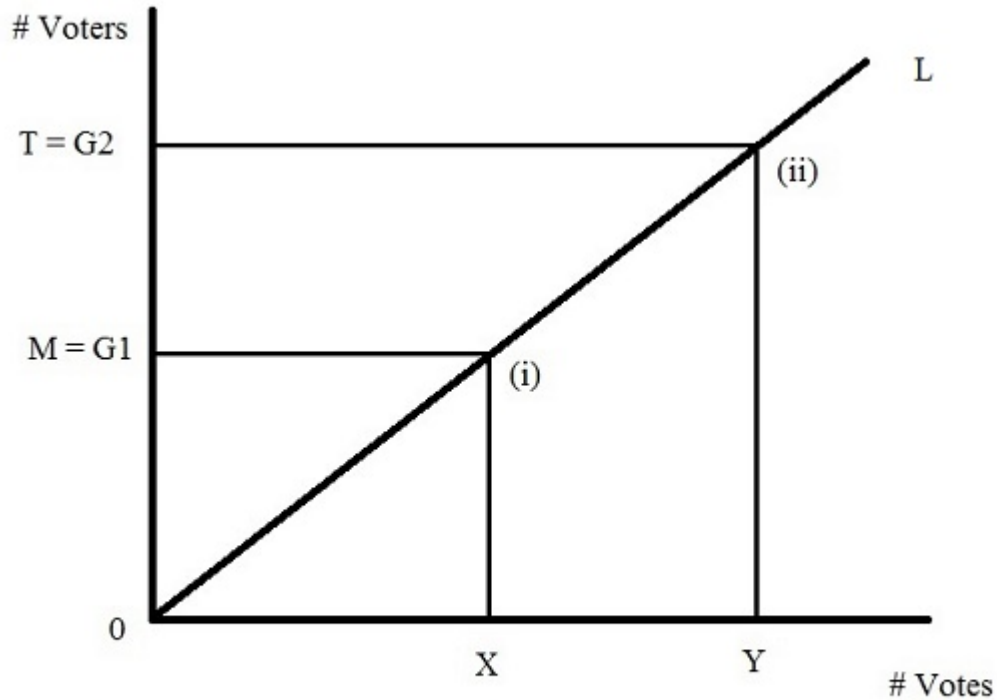

Figure 6 The democratic outcome line: it matches the number of votes received by each group one vote per person under no complacency(NC) so that the true majority $T = G_2$ got Y votes; and the true minority $M = G_1$ received X votes.

Notice that Figure 6 above summarizes the structure of a normal democratic outcome(NDO) resulting from a majority based voting system(V) working under no complacency(NC), where everybody participates and everybody votes, matching that way the number of individuals in each group with the number of votes received by each group($G_1 = X$ and $G_2 = Y$). In others world, the democratic outcome line(L) showed in Figure 6 above matches the votes received by each group, where the true minority M gets X votes and the true majority T gets Y votes.

b) The complacency range line(CRL)

Complacency(C) or protest behavior may lead to a total or partial collapse of votes of the true majority(T) or the true minority(M); and this complacency behavior(C) determines the resulting democratic outcome. And since complacency(C) is negatively associated with harmony or stability, the more complacency or protest behavior in the democratic process the less harmony or stability in the determination of the democratic outcome is to be expected.

In other words, the wider the complacency range(CR), the wider the possible vote collapse due to protest behavior, and therefore the less harmony or stability in the determination of the democratic outcome(DO). Hence, the wider the complacency range(CR) or the larger the size of protest behavior the more unpredictability with respect to the resulting democratic outcome(DO). This situation can be appreciated by looking at the direction of the arrow representing the complacency range line(CRL) in Figure 7 below:

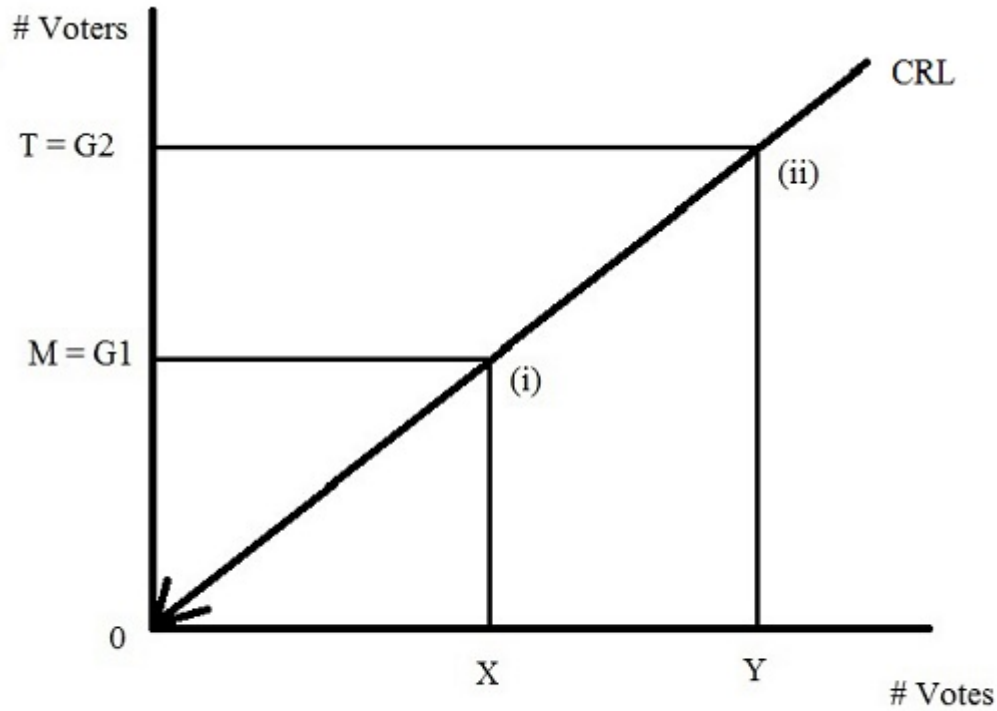

Figure 7 The complacency range line: The true majority(T) complacency range goes from point (ii) to zero; and the true minority(M) complacency range goes from point (i) to zero.

The arrow moving towards zero in Figure 7 above indicates the direction in which complacency(C) or protest behavior can make the true majority(T) and the true minority(M) vote collapse. Therefore, the complacency range(CR) for the true majority(T) in Figure 7 above goes from point (ii) to zero if the true majority vote collapses completely; and the complacency range(CR) for the true minority(M) goes from point (i) to zero if the minority vote collapses completely. We can see in Figure 7 above that when there is complacency(C) or protest behavior, there is vote collapse, and under those conditions a normal democratic outcome(NDO) is no longer guaranteed all the time as now the possibility of having an extreme democratic outcome(EDO) exists.

c) The no complacency points line(NCPL)

When there is no complacency(NC) or no protest behavior we have a normal democratic outcome(NDO) as indicated in the introduction. In other words, when there is true majority no complacency(TNC) and true minority no complacency(MNC) at the same time, we have a normal democratic outcome(NDO) under majority rule. The points of true majority no complacency(TNC) and of true minority no complacency(MNC) are shown in Figure 8 below:

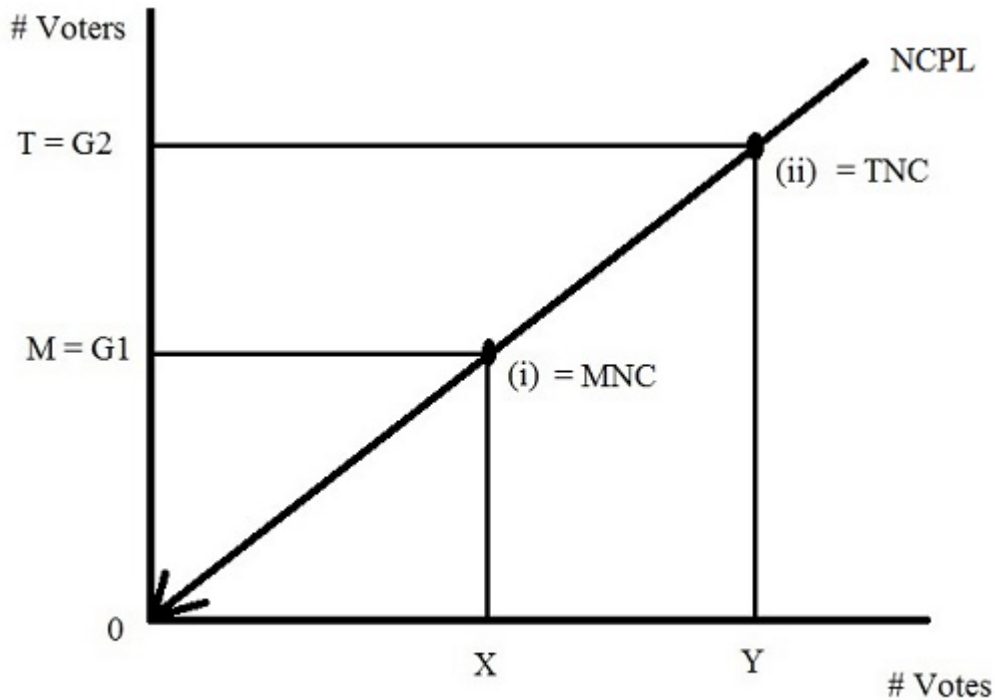

Figure 8 The no complacency points line: There is true majority no complacency(TNC) at point (ii); and there is true minority no complacency(MNC) at point (i); and therefore, $T = G2 > M = G1$.

We can see in Figure 8 above that under no complacency(NC) or no protest behavior everybody participates and everybody votes in the true majority(T) and in the true minority(M); and therefore, there are two normal democratic outcome(NDO) no complacency(NC) points: 1) the true majority no complacency point(TNC) at point (ii)-the true majority(T) votes at point (ii) so $T = Y$ votes; and 2) the true minority no complacency point(MNC) at point (i)-the true minority(M) votes at point (i) so $M = X$ votes; and under those conditions the true majority T wins. The situation in Figure 8 above is one of harmony or stability as it is normal democratic outcomes(NDO), the result of full no complacency(FNC) as there is true majority no complacency(TNC) and true minority no complacency(MNC) at the same time. In other words, under no complacency(NC) or no protest behavior we always have a normal democratic outcome(NDO).

d) The complacency points line(CPL)

When there is complacency(C) or protest behavior, then we can think about complacency points associated with the true majority(T) and with the true minority(M) and about vote collapses; and therefore, we can think about the instability in the determination of the democratic outcome that they bring, which are indicated in Figure 9 below:

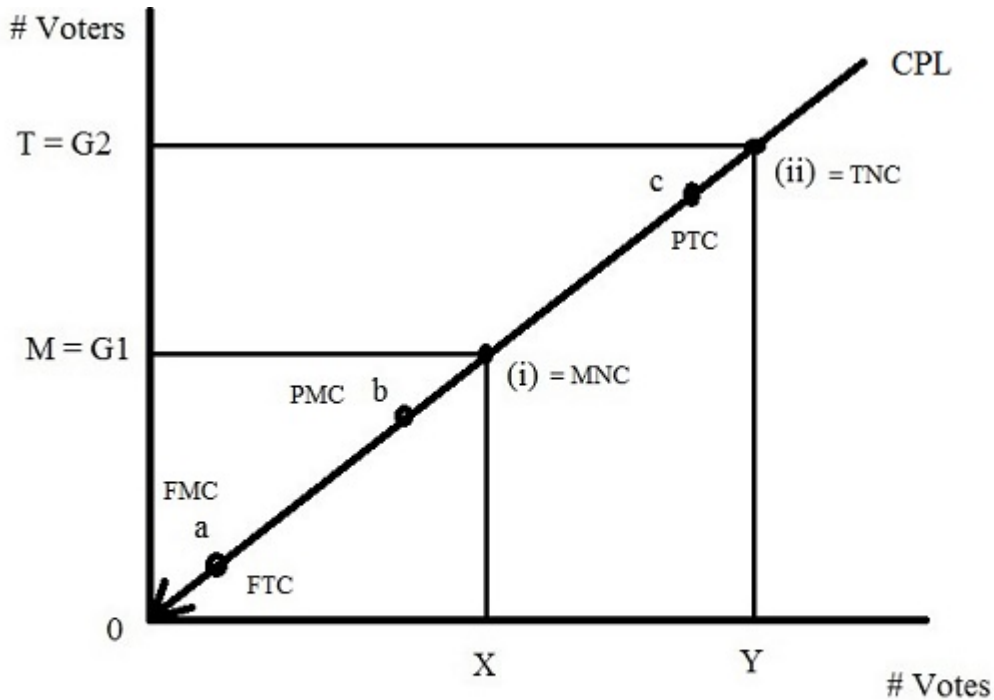

Figure 9 Complacency points line: There is partial true majority complacency(PTC) at point "c"; and there is full true majority complacency(FTC) at point "a". There is partial true minority complacency(PMC) at point "b"; and there is full true minority complacency(FMC) at point "a".

We can see in Figure 9 above the following complacency points: 1) a point of partial true majority complacency(PTC) at point "c"; 2) a point of full true majority complacency(FTC) at point "a"; 3) a point of partial true minority complacency(PMC) at point "b"; and 4) a point of full true minority complacency(FMC) at point "a".

With respect to the true majority(T), vote collapse, and the resulting democratic outcome, other things being equal, we can use Figure 9 above to highlight the following: 1) Point "c" is a point of partial true majority complacency(PTC) or partial protest behavior, it collapses a little from point (ii) to point "c", but still the true majority wins as $Y - c > X + c$ and "c" is the size of the true majority(T) vote collapse under partial complacency(PC); and 2) point "a" is a point of general true majority complacency(FTC) or full protest voting or behavior, it collapses so much from point (ii) to point "a" that the true minority(M) wins as $Y - a < X + a$, where "a" is the size of the true majority(T) collapse under full complacency(FC). Therefore, under partial true majority complacency(PTC) the true majority T wins, but with a smaller true majority; and under full true majority complacency(FTC) the true minority M wins and therefore we have an extreme democratic outcome(EDO). Hence, the unexpected outcome happens, the extreme democratic outcome(EDO), only when there is full true majority complacency(FTC) or widespread true majority protest behavior.

With respect to the true minority(M), vote collapse and the resulting democratic outcome, other things being equal, we can say from Figure 9 above that: 1) point “a” is a point of general true minority complacency(FMC) or protest behavior, it collapses a lot from point (i) to point “a”, where “a” is the size of the true minority(M) collapse under general complacency(FC); and it loses the election to the largest true majority(T) since $Y + a > X - a$; and 2) point “b” is a point of partial true minority complacency(PTM) or protest voting or behavior as it collapses a little from point (i) to point “b”, where “b” is the size of the true minority(M) collapse under partial complacency(PC) losing the election to a bigger true majority(T) as $Y + b > X - b$. Therefore, under full true minority complacency(FMC) the true minority M loses to the largest true majority; and under partial true minority complacency(PMC) the true minority M loses too to a larger true majority;

The true majority based voting model(V)

Analytically, the true majority rule based voting model(V) mentioned in the introduction, can be stated as:

$$1) V = TM \text{ -----} \rightarrow T \text{ wins} = \text{NDO}$$

The statement in formula 1) above holds true because if everybody participates and votes and the voters are aggregated into two groups, the true majority(T) and the true minority(M), then by majority rule the true majority T wins since $T > M$, which is a normal democratic outcome(NDO). This situation can be appreciated graphically as indicated in Figure 10 below:

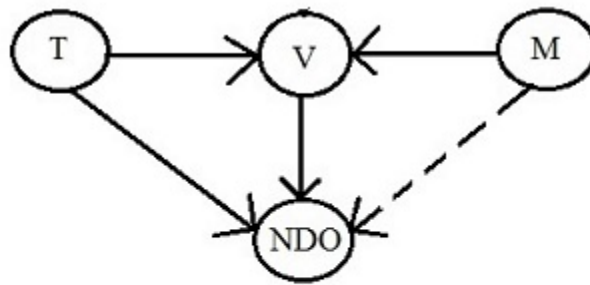

Figure 10 Majority rule based voting system(V): It brings together the true majority(T) and the true minority(M), where the true majority wins($T > M$) ensuring a normal democratic outcome(NDO).

Figure 10 above says that the voting system(V) brings together two groups, a true majority(T) and a true minority(M), where the true majority T wins because $T > M$, which is a normal democratic outcome(NDO). It can be seen clearly in Figure 10 above that the only democratic outcome(DO) that can come out of the majority rule based system above is a normal democratic outcome(NDO).

The true majority based voting model under no complacency{NC[V]}

When all participants from the true majority(T) and the true minority(M) vote and the number of votes matches the number of participants as indicated in the operational concepts and models, there is no complacency(NC). In other words, when there is full participation and full voting there is no protest behavior; and therefore, there is no complacency(NC), each member of the true majority(T) and of the true minority(M) votes for their preferred candidate or option as expected. The true majority voting system(V) under no complacency(NC) can be indicated analytically as follows:

2) $NC[V] = NC[TM] \text{ -----} \rightarrow T \text{ wins} = NDO$

The formula 2 above clearly says that when the voting system(V) is under no complacency{NC[V]}, the true majority T wins since $T > M$, which is a normal democratic outcome(NDO). This situation can be stated graphically as follows:

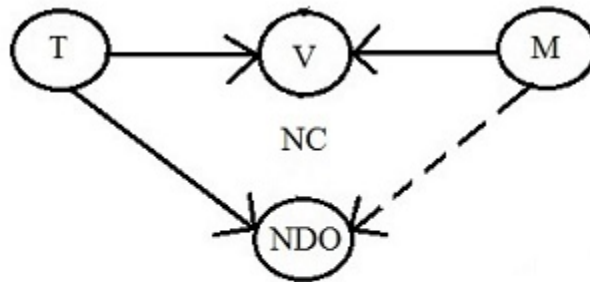

Figure 11 The structure of normal democratic outcomes(NDO): Under no complacency(NC) the true majority(T) wins as $T > M$.

See that Figure 11 above tells us that under no complacency(NC) or protest behavior the voting outcome under majority rule leads to a normal democratic outcome(NDO). Therefore, if there is no complacency(NC) the voting contest will produced a normal democratic outcome(NDO) so we should expect a normal democratic outcome(NDO) under no complacency(NC) always.

The true majority based voting model under complacency{C[V]}

If there is complacency(C) or protest behavior affecting the voting contest(V) then we cannot always expect a normal democratic outcome(NDO) as it is now possible to have an extreme democratic outcome(EDO) too. The voting model(V) under complacency(C) can be represented analytically as indicated below:

3) $C[V] = C[TM] \text{ -----} \rightarrow ? = DO$

Formula 3) above says that when the voting system(V) is under complacency{C[V]}, the resulting democratic outcome(DO) is unknown(?) as we do not know if the true majority(T) or the true minority(M) will win. Not knowing how much

protest behavior is affecting each of them makes democratic outcome(DO) prediction difficult. This situation can be highlighted graphically as follows:

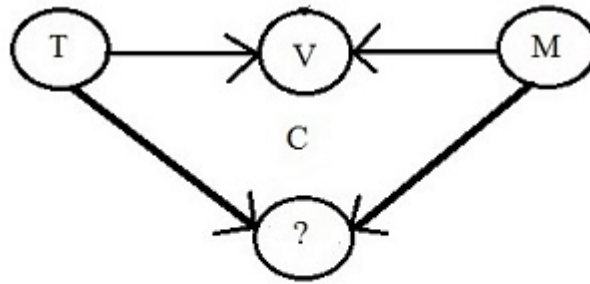

Figure 12 A hard to call democratic outcome: Under complacency(C) you do not know who will win.

Figure 12 above says that if the voting system(V) brings together the true majority(T) and the true minority(M) under complacency(C) or protest behavior we do not know who will win(?) as indicated by continuous arrows from T and M to ?. Hence, if there is complacency(C) affecting the voting system(V) any outcome even extreme democratic outcomes(EDO) are possible.

The true majority based voting model under full true majority complacency{FTC[V]}

As indicated in the operational concepts and models if there is full true majority complacency(FTC) or protest behavior affecting the voting system(V), the true minority M will win the contest leading to an extreme democratic outcome(EDO). This situation can be stated analytically as follows:

4) $FTC[V] = FTC[TM] \text{ -----} \rightarrow M \text{ wins} = EDO$

The formula 4 above clearly tells us that when the voting system(V) is under full true majority complacency{FTC[V]}, the true minority M wins since $T < M$, which is an extreme democratic outcome(EDO). This situation can be indicated graphically as follows:

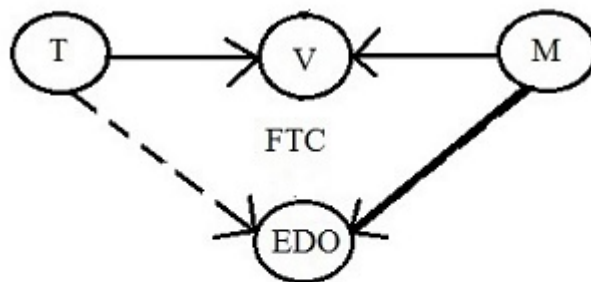

Figure 13 The structure of extreme democratic outcomes(EDO): Under full true majority complacency(FTC) the true minority(M) wins as now $T < M$.

Figure 13 above tells us that when the voting system(V) brings together the true majority(T) and the true minority(M) under full true majority complacency(FTC) or protest behavior it leads to an extreme democratic outcome(EDO) as the true minority M wins since $M > T$. The continuous line arrow from M to EDO means the true minority M wins.

The true majority based voting model under partial true majority complacency{PTC[V]}

As indicated in the operational concepts and models if there is partial true majority complacency(PTC) or protest behavior affecting the voting system(V), the true majority T will win the contest as still $T > M$ leading to a normal democratic outcome(NDO) with a smaller true majority ruling. This situation can be stated analytically as follows:

5) $PTC[V] = PTC[TM] \text{ -----} \rightarrow T \text{ wins} = NDO$

The formula 5 above tells us that when the voting system is under partial true majority complacency{PTC[V]}, the true majority T still wins since still $T > M$, which is still a normal democratic outcome(NDO) with a smaller majority. This situation can be indicated graphically as follows:

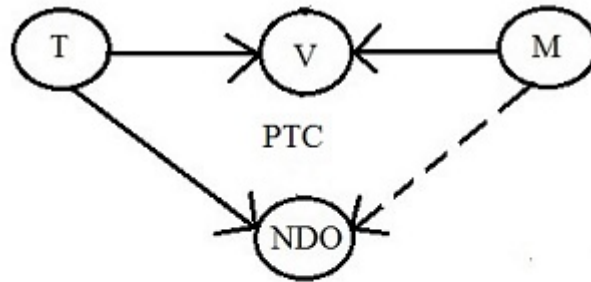

Figure 14 The structure of normal democratic outcomes(NDO) under partial true majority complacency(PTC): Under partial true majority complacency(PTC) the true majority T wins as still $T > M$.

Figure 14 above says that when the voting system(V) brings together the true majority(T) and the true minority(M) under partial true majority complacency(PTC) or protest behavior it leads still to a normal democratic outcome(NDO) as the true majority T wins since still $T > M$. The continuous line arrow from T to NDO means the true majority T wins.

Summary:

- i) Majority rule voting systems(V), one person one vote when all participants vote, lead to normal democratic outcomes(NDO) where the true majority T wins;
- ii) Majority rule voting systems(V) under no complacency(NC) or no protest behavior lead to normal democratic outcomes(NDO) where the true majority T wins;
- iii) Majority rule voting systems(V) under complacency(C) or protest behavior lead to hard to predict democratic

outcomes, any outcome is possible; iv) Majority rule voting systems(V) under full true majority complacency(FTC) or protest behavior lead to extreme democratic outcomes(EDO) where the true minority M wins; and v) Majority rule voting systems(V) under partial true majority complacency(PTC) or protest behavior lead to normal democratic outcomes(NDO), but of a smaller true majority.

Implications:

a) Extreme democratic outcomes(EDO) take place when the true majority(T) is under full complacency or full protest behavior or full chaos; b) Normal democratic outcomes(NDO) take place when there is no complacency or no protest behavior or no chaos; and therefore, c) complacency or protest behavior(C) is relevant to understanding the conditions leading to specific types of democratic outcomes, maximize complacency and you will likely have an extreme democratic outcome(EDO) or minimize complacency and you more likely will have a normal democratic outcome(NDO).

Food for thoughts

a) Are BREXIT and USEXIT anti-majority rule democratic outcomes?, I think yes, what do you think?; b) Is chaos needed for extreme democratic outcomes to materialize and be sustained?, I think yes, what do you think?; c) Should extreme democratic outcomes be treated as normal democratic outcomes in terms of policy action or reaction?, I think no, what do you think?; d) Should we expect extreme democratic outcomes to reflect the will of the majority after they take place?, I think no, what do you think?; e) Are extreme democratic outcomes a point of full democratic instability?, I think yes, what do you think?; and f) Can there be full true majority complacency without chaos?, I say no, what do you think?.

Specific conclusions

It was pointed out that true democracy under a majority rule based system assumes full participation and full voting as the means to ensure normal democratic outcome where the true majority wins. It was stressed that this assumption is in essence an assumption of no complacency as there is no protest behavior; and it was shown that a voting contest under no complacency leads to normal democratic outcomes only, where the true majority wins.

It was indicated that when the voting system is under complacency or protest behavior, we do not know who will win; and therefore, any democratic outcome, including extreme democratic outcomes, is possible. It was highlighted that when the voting system is under full true majority complacency or protest behavior we have an extreme democratic outcome as the true minority wins. And finally, it was pointed out that if the voting system is under partial true majority complacency or protest behavior, we still get a normal democratic outcome with a smaller true majority.

General conclusions

It was stressed that the concept of complacency helps to understand the different outcomes that can be had when protest behavior affects the true majority rule based democratic process as specific democratic outcomes are associated with specific types of complacency. It was indicated that if the true majority voting system is under no complacency then we get the same normal democratic outcome you are expected to get by the majority system model that assumes full participation and full voting or not protest behavior.

It was pointed out that when there is complacency or protest behavior you cannot see the nature of the winning democratic outcome as we do not know how much complacency behavior affects the true majority and the true minority vote. And therefore under those conditions even an extreme democratic outcome is possible. It was indicated that only when there is full true majority complacency or protest behavior we must expect an extreme democratic outcome, but if we have only partial true majority complacency we should still expect a normal democratic outcome with a smaller true majority.

References

Becker, Paula and Jean-Aimé A. Raveloson, 2008. [*What is Democracy?*](#) , September, Hamburg, Germany.

British Broadcasting Corporation(BBC), 2016a. [*US election 2016: Republican divisions grow over Trump*](#), August 03, News US Election, London, UK.

British Broadcasting Corporation(BBC), 2016b. [*Eight reasons Leave won the UK's referendum on the EU*](#), EU Referendum News, June 24, London, UK.

British Broadcasting Corporation(BBC), 2016c. [*Brexit: Europe stunned by UK Leave vote*](#), EU Referendum News, June 24, London, UK.

British Telecommunications(BT), 2016. [*7 of the most bizarre Brexit conspiracy theories out there*](#), June 16, London, UK/

Byers, Dylan, 2016. [*How politicians, pollsters and media missed Trump's groundswell*](#), November 09, CNN, Atlanta, Georgia, USA.

Cohn, Nate, 2016a. [*Why the Surprise Over 'Brexit'? Don't Blame the Polls*](#), June 24, The Upshot Political Calculus, The New York Times, NY, NY, USA.

Cohn, Nate, 2016b. [*Why Trump Won: Working-Class Whites*](#). November 09, The Upshot, The New York Times, NY, NY, USA.

Chicago Tribune(CT), 2016. [*After earlier turmoil, Republicans seek to mend party divisions on RNC's opening night*](#), July 19, News, National Politics, Chicago, IL, USA.

- Democracy Web(DW), 2017. [*Majority Rule/Minority Rights: Essential Principles*](#), Albert Shanker Institute, Washington, DC, USA.
- Gaber, Ivor, 2016. [*Bending over backwards: the BBC and the Brexit campaign*](#), EU Referendum Analysis 2016, Section 4: Journalism, London, UK.
- Gifford, Chris, 2016. [*Brexit: the destruction of a collective good*](#), EU Referendum Analysis 2016, Section 1: Context, London, UK.
- Gore, Will, 2016. [*The media missed the real story about Brexit divides – it's not about age, it's all about class*](#), Monday, July 04, The Independent, London, UK.
- Grice, Andrew, 2017. [*Fake news handed Brexiteers the referendum—and now they have no idea what they're doing*](#), January 18. Voices, The Independent, London, UK.
- Hohmann, James, 2016. [*The Daily 202: Why Trump won -- and why the media missed it*](#), November 09, The Washington Post, Washington, DC, USA.
- Horton, Helena, 2016. [*The five weirdest conspiracy theories about the US Election*](#), News, November 07, The Telegraph, London, UK.
- Human Rights Council(HRC), 2016. [*Summary of the discussions held during the expert workshop on the right to participate in public affairs*](#), July 15, United Nations, New York, NY, USA
- Ingram, Mathew, 2016. [*Here's Why the Media Failed to Predict a Donald Trump Victory*](#), November 09, FORTUNE, Tampa, Florida, USA.
- Jackson, Nathalie, 2016. [*How Brexit Polls Missed The 'Leave' Victory*](#), June 24, Politics, HUFFPOST, The Huffington Post, London, UK.
- Lewis, Rachel, Rob Richie and Jack Santucci, 2006. [*Majority Rule in International Presidential Elections The Dominant Role of Runoffs Around the World*](#), June 06, Fair Vote Research Report, Takoma Park, MD, USA.
- Muñoz, Lucio, 2015. [*Moral and Practical Sustainability Gaps: Implications for the Current Liberal Development Model*](#), *Weber Sociology & Anthropology* (ISSN:2449-1632), Vol. 1 (4) 2015, Article ID wsa_149, 317-320.
- Rawlinson, Kevin, 2016. [*The world's newspapers react to Trump's election victory*](#), Thursday, June 10, London, UK.
- Rentoul, John, 2016. [*The Top 10: Conspiracy Theories*](#), July 09, The Independent, London, UK.

Rogers, Katie and Jonah Engel Bromwich, 2016. [*The Hoaxes, Fake News and Misinformation We Saw on Election Day*](#), November 08, The New York Times, NY, NY, USA

The Globe and Mail(TGAM), 2016a. [*Democratic convention: Hillary Clinton finds her voice while attacking Donald Trump*](#), US Election 2016, July 24, Toronto, ON, Canada.

The Globe and Mail(TGAM), 2016b. [*Trump is president. What happens now? A morning-after guide to the U.S. election, US Election 2016*](#), November 08, Toronto, ON, Canada.

The Telegraph(TT), 2016. [*Divisions on show at Democratic Party Convention*](#), Opinion, July 27, London, UK.

United Nations(UN), 1976. [*International Covenant on Civil and Political Rights*](#), March 23, New York, NY, USA.

Uscinski, Joseph. 2016. [*The 5 Most Dangerous Conspiracy Theories of 2016*](#), August 22, Politico Magazine, Arlington, VA, USA.

Williams, Walter E., 2009. [*Democracy and Majority Rule*](#), Arlington, VA. USA.

Wintour, Patrick, 2016. [*UK voted for Brexit – but is there a way back?*](#), Wednesday, June 29, The Guardian, London, UK.